



**SCHWAB CORP.**

Fire protection for vital records.™

*Protection and Security for over a Century!*



The strength and reliability of a Schwab Underwriters' Laboratories Rated Insulated Vault or File Room Door draws from over 135 years of protecting your records and other valuables.

The Insulated Vault Door should be utilized where an N.F.P.A. rated fire resistant vault is appropriate. The Insulated File Room Door could be specified in an instance where the construction of a fire resistant vault is impractical, but maximum protection from fire is still warranted.

All Schwab doors carry a Class B Mercantile Burglary Insurance rating for security, Underwriters Laboratories, Inc. labels and certifications for times specified.

The unique design of the Schwab door frame allows for easy, non-grout installation in walls 7" - 18" thick.

For further protection and safety, each door includes an inside escape mechanism which can be easily located and operated, even in the dark. A relocking device automatically resets the lock bolt if the lock sustains an attack.

A beveled vault threshold allows for easy passage of wheeled carts as well as a seamless transition of the door and its environment.

**INSULATED VAULT  
AND FILE ROOM DOORS**

Schwab's attractive Vault and File Room Doors come in several colors and can be adjusted to accommodate a variety of wall thicknesses. All doors undergo rigorous testing by Underwriters Laboratories, Inc., including fire endurance tests for variable times, as well as additional tests involving water blasts to simulate firehose spray and reheating for 1/2 hour. Every Schwab door performs at a level which exceeds its UL required rating.

# INSULATED FILE ROOM DOOR

**CLASS 350-1 HOUR**

## ARCHITECT'S SPECIFICATIONS

The contractor will furnish and install (quantity) Schwab (No. 7832-1 or No. 7840-1) one-hour Insulated File Room Door(s), non-grout, flat sill type. Door will bear this label: Underwriters' Laboratories, Inc., Class 350-1 hour Fire Rated.

Door will be 5<sup>3</sup>/<sub>8</sub>" thick, with clear opening (78" H x 32" W or 78" H x 40" W). Vestibule will be adjustable to accommodate wall thickness of (7" to 18"-actual wall thickness must be specified). Entrance will be tapered no more than 10°. Rear architrave will be removable.

Door will be locked with 10 live bolts, each 1<sup>1</sup>/<sub>4</sub>" in diameter, located five on each side of door. All exposed boltwork will be heavily nickel-plated and permanently lubricated. Boltwork automatically retracts when handle is opened, and automatically extends when the door shuts, unless non-standard locking options are used.

Bolts will be checked by a three-tumbler Group II Key Change Combination Lock equipped with a Relocking Device to reset lock bolt if lock is damaged by tool attack. A second relocking device within the door, will automatically deadlock door bolts in the event of tool attack. Door will be equipped with an inside escape mechanism.

Door will swing (right, left) with hinges on (right, left) when facing door. Hinges will have roller-thrust bearings. Door frame will be furnished with leveling screws. Door will be installed in accordance with manufacturer's instructions supplied with each door.

Door will be finished in textured paint. Color: gray, charcoal, forest green or tan.

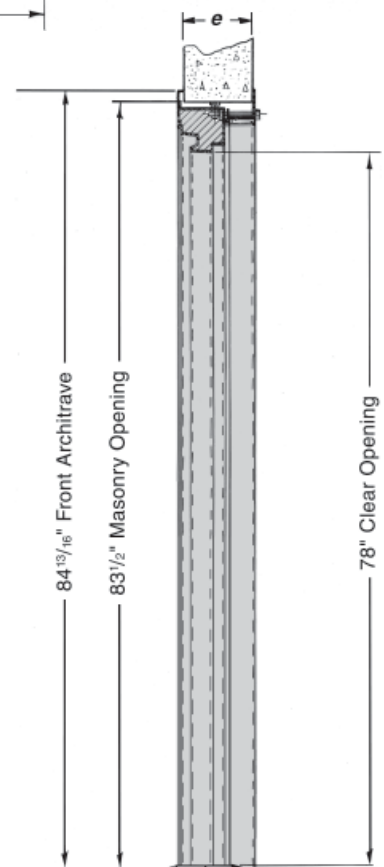
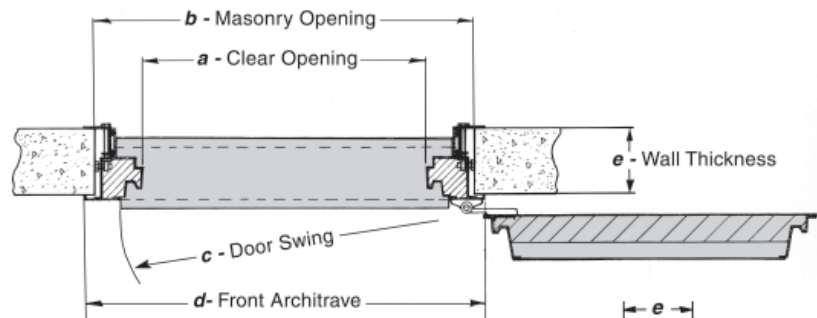

## FACTORY OPTIONS

Stainless steel hinge cover is available. Installation instructions are furnished with each door.

## FILE ROOM DOOR DIMENSION SCHEDULE



Vault Door Model No.	a	b	c	d	e	Approx. Shpg. Wt.
7832-1	32"	42 1/2"	39"	45 1/8"	7"-18"	945 lbs.
7840-1	40"	50 1/2"	47"	53 1/8"	7"-18"	1,073 lbs.

## NOTE

Schwab Vault Doors are designed to accommodate a wall thickness of 7" to 18". When ordering, please specify wall thickness.

Both doors are equipped with a Standard Key Change Combination Lock as well as a Relocking Device Mechanism. Non-standard locking options are also available. The Schwab File or Vault Room Door will give the customer the same assurance that banks, schools, hospitals and many residential customers have relied on for over 130 years of protecting their valuables from fire and theft.

## INSULATED VAULT DOOR

CLASS 350-2 HOUR, 350-4 HOUR & 350-6 HOUR

### ARCHITECT'S SPECIFICATIONS

The contractor will furnish and install (quantity) Schwab (No. 7832-2, 4, or 6; or No. 7840-2, 4, or 6) Vault Door(s), non-grout, flat sill type. Door will bear this label: Underwriters' Laboratories, Inc., Class 350 (2, 4, or 6) hour Fire Rating.

Door will be 5<sup>5</sup>/<sub>8</sub>" thick, with clear opening (78" H x 32" W or 78" H x 40" W). Vestibule will be adjustable to accommodate wall thickness of (7" to 18"-actual wall thickness must be specified). Entrance will be tapered no more than 10°. Rear architrave will be removable.

Door will be locked with 10 live bolts, each 1<sup>1</sup>/<sub>4</sub>" in diameter, located five on each side of door. All exposed boltwork will be heavily nickel-plated and permanently lubricated. Boltwork automatically retracts when handle is opened, and automatically extends when the door shuts, unless non-standard locking options are used.

Bolts will be checked by a three-tumbler Group II Key Change Combination Lock equipped with a Relocking Device to reset lock bolt if lock is damaged by tool attack. A second relocking device within the door, will automatically deadlock door bolts in the event of tool attack. Door will be equipped with an inside escape mechanism.

Door will swing (right, left) with hinges on (right, left) when facing door. Hinges will have roller-thrust bearings. Door frame will be furnished with leveling screws. Door will be installed in accordance with manufacturer's instructions supplied with each door.

Door will be finished in textured paint. Color: gray, charcoal, forest green or tan.

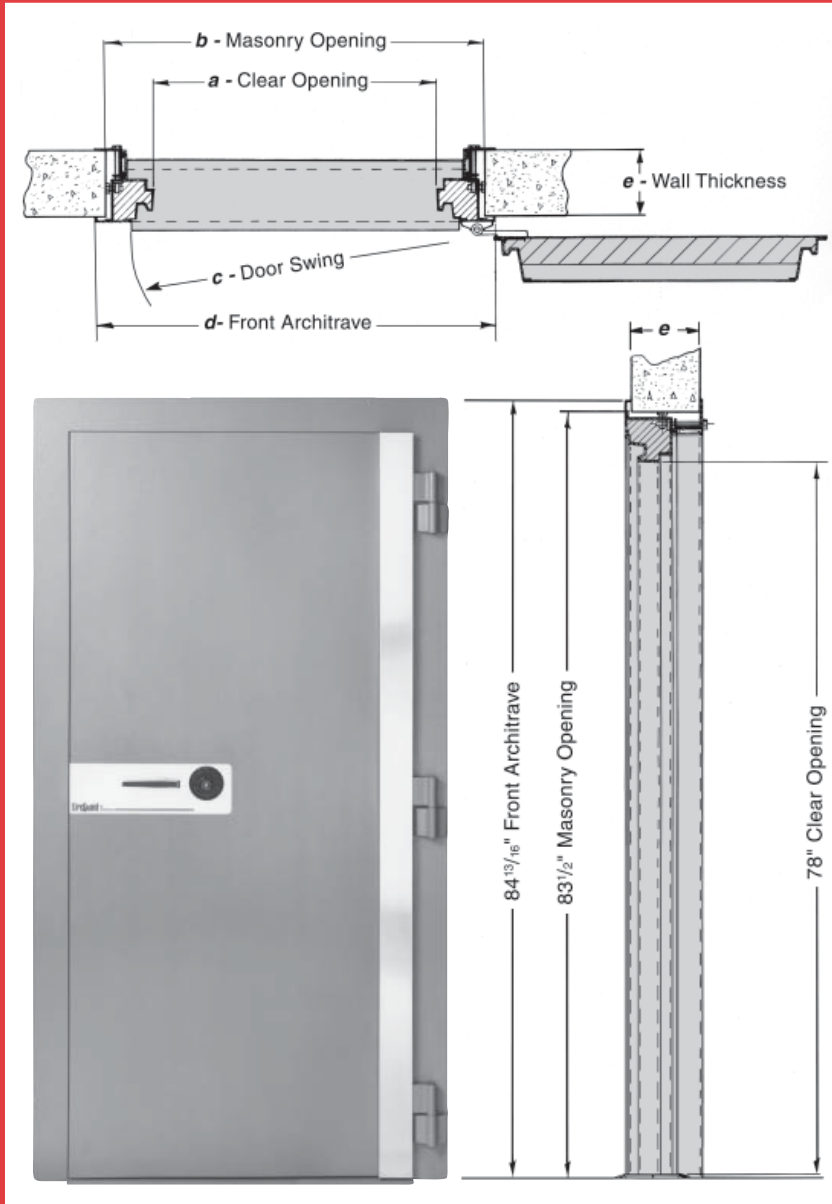

### FACTORY OPTIONS

Stainless steel hinge cover is standard on 4 and 6 hour doors only. Optional at extra cost on 2 hour doors. Installation instructions are furnished with each door.

### VAULT DOOR DIMENSION SCHEDULE

Vault Door Model No.	a	b	c	d	e	Approx. Shpg. Wt.
7832-2	32"	42 1/2"	39"	45 1/8"	7"-18"	972 lbs.
7840-2	40"	50 1/2"	47"	53 1/8"	7"-18"	1,100 lbs.
7832-4	32"	42 1/2"	39"	45 1/8"	7"-18"	990 lbs.
7840-4	40"	50 1/2"	47"	53 1/8"	7"-18"	1,118 lbs.
7832-6	32"	42 1/2"	39"	45 1/8"	7"-18"	1,019 lbs.
7840-6	40"	50 1/2"	47"	53 1/8"	7"-18"	1,147 lbs.

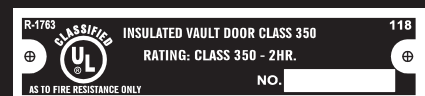

# ESCAPE MECHANISM ON ALL DOORS

## SCHWAB DAY GATES



Designed specifically for use with Schwab Vault Doors, day gates restrict unauthorized entrance during hours the vault door is open.

Deluxe Plexiglass Gate has a brushed aluminum finish. Gate fastens to the inside of vault frame. Hinge allows gate to swing easily into vault. Equipped with heavy duty key lock.

Direction of day gate swing is determined by viewing day gate from inside the vault. Right swing hinges on right; left swing is the reverse.

Day Gate Model No.	Description	Approximate Shipping Weight
DGPLX32	32" Plexiglass	175 lbs.
DGPLX40	40" Plexiglass	185 lbs.



### STANDARD FINISHES

Choice of gray, charcoal, forest green or tan textured finish. Custom colors are available-consult with your Service Representative.

### PRODUCT AVAILABILITY

Generally, except during peak periods, Schwab vault doors are shipped within three weeks of order confirmation. Quik Ship Program is available on stocked models and colors. For custom orders, an additional two weeks may be required.

### SHIPPING METHODS

To protect the quality finish and to assure good condition upon arrival, Schwab Vault Doors are factory packaged in a rugged 1/2" plywood and hardwood container. Exposed surfaces are further protected by a plastic "air cushion" material.

## OPTIONAL AUTOMATIC DOOR CLOSER

### INSIDE VIEW

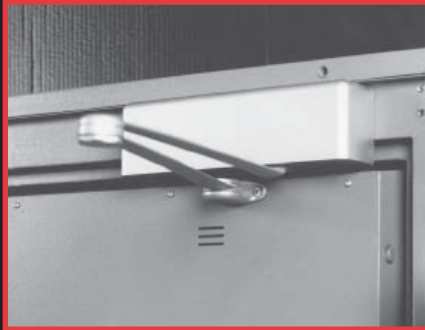

Automatic door closer uses an electromagnetic system that releases the door when the sensor detects either heat or smoke. Closer then automatically shuts the door from its regular 180° open position. Sensor is not included in closer package.

### OUTSIDE VIEW

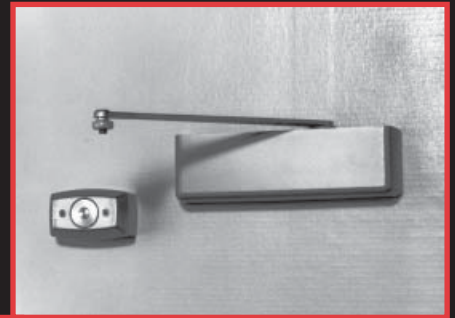

## DOOR SWING

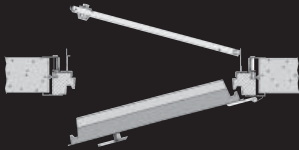

Right Swing Vault Door-Left Swing Daygate

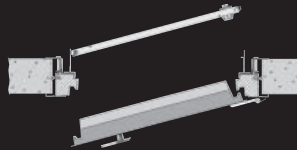

Right Swing Vault Door-Right Swing Daygate



Left Swing Vault Door-Right Swing Daygate

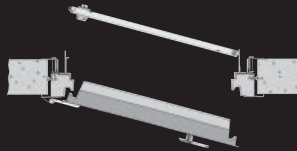

Left Swing Vault Door-Left Swing Daygate

## ORDER CHECK LIST

Door Model No. \_\_\_\_\_

Wall Thickness \_\_\_\_\_  
(7"-18"-must be specified)

Color \_\_\_\_\_  
(gray, charcoal, forest green, tan)

Door Swing \_\_\_\_\_  
(right or left\*)

Day Gate Model No. \_\_\_\_\_

Gate Swing \_\_\_\_\_  
(right or left\*)

Authorized by \_\_\_\_\_

\*Swing is determined by facing door from *outside* vault. Hinges on right side denote right swing; hinges on left side denote left swing. Swing of day gate is determined in the same manner, facing the gate from *inside* the vault. Please see illustrations at left for clarification.



Fire protection for vital records.™

P.O. Box 5088 • Lafayette, Indiana 47903 • www.schwabcorp.com  
(765)447-9470 • (800)447-7233 • FAX (765)447-8278